

LEDLENSER P4R

P4R Core

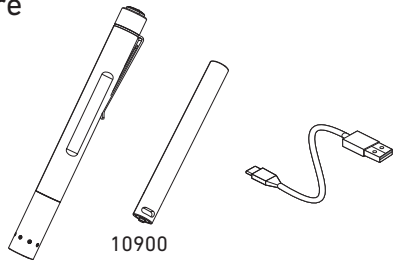

P4R Work

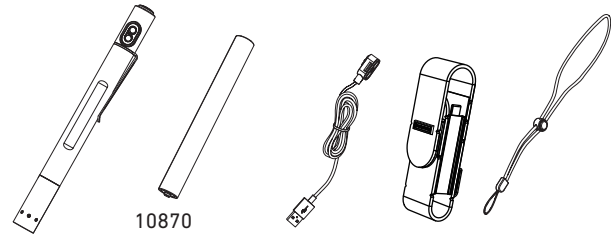

Battery Replacement

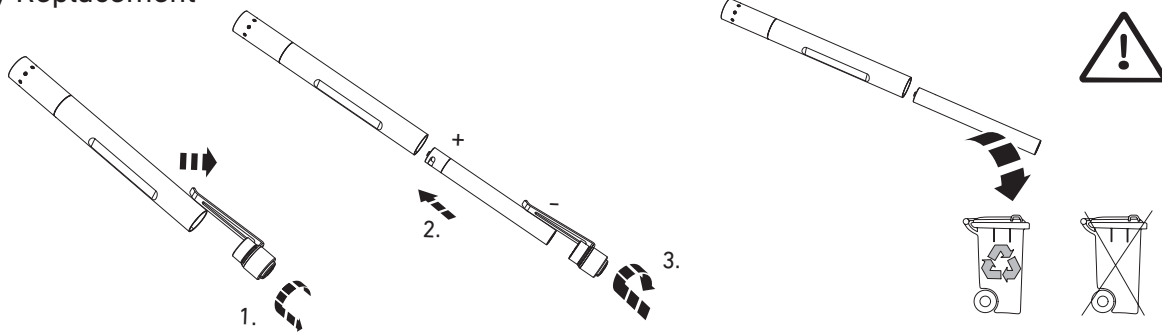

Operation

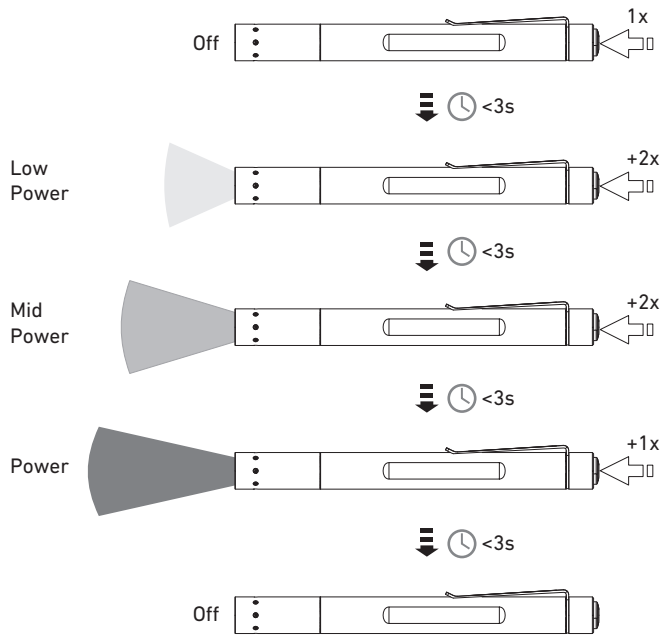

Advanced Focus System

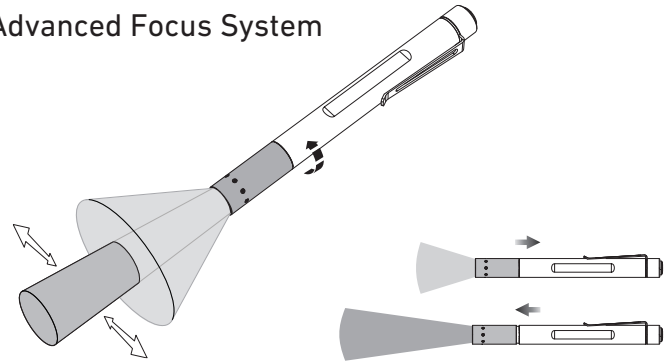

Pouch (P4R Work)

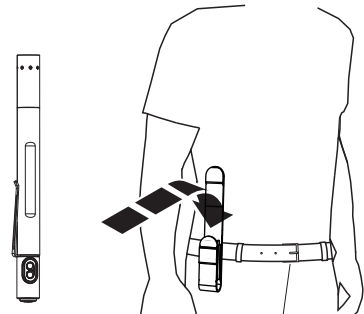

LEDLENSER P4R

Battery Charging System (P4R Core)

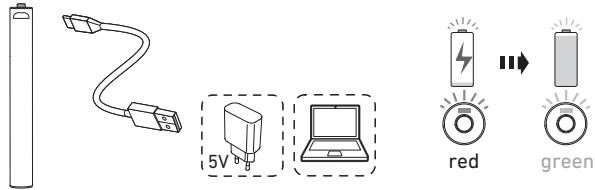

Further Information

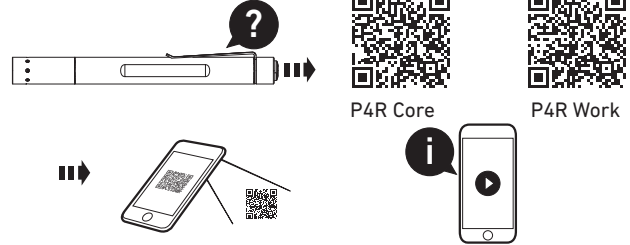

Magnetic Charging System (P4R Work)

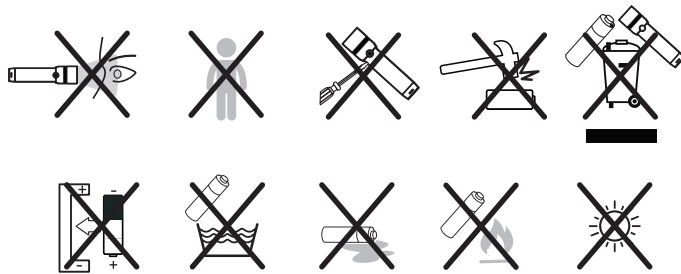
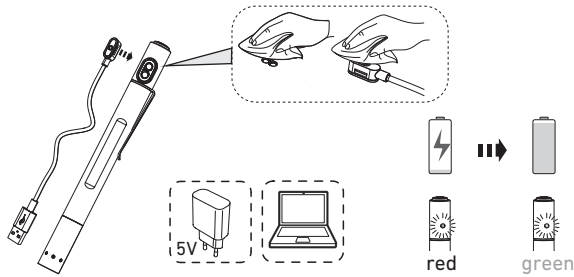

Ledlenser GmbH & Co. KG
 Kronenstrasse 5-7 • 42699 Solingen • Germany
 Phone +49 212/5948-0 Fax +49 212/5948-200
 info@ledlenser.com



ledlenser.com



P4R_V02
 2021.07.06
 1J12A0448